

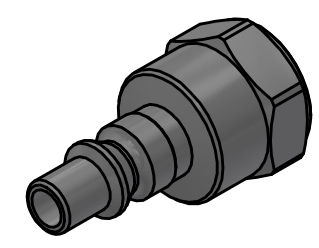

This document must not be copied, either completely or in part, without permission. Any infringement will have legal consequences ©

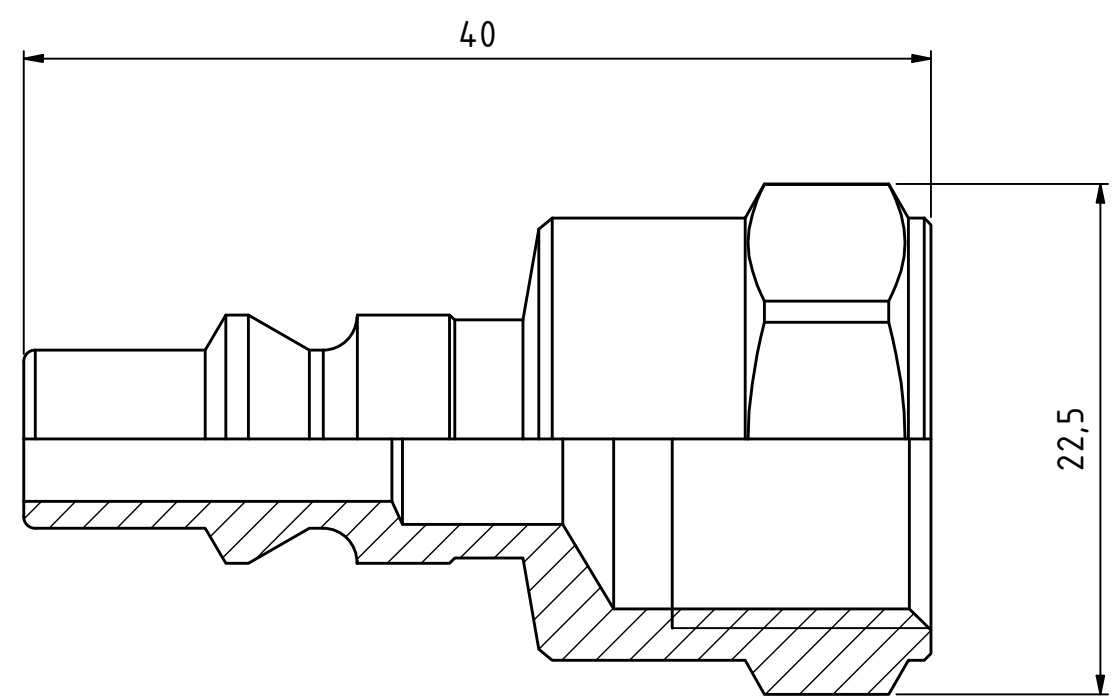

1 : 1



Product No.	103005204
Nominal flow Ø DN:	5,5 mm
Connection Stroke:	mm
Max WP Connected:	16 bar
Min BP Connected:	140 bar
Temperature range:	-20°C - +100°C
Connection:	G 3/8" Fem
Sealing material:	
Hexagon:	20

1	1	Nipple	Hard. Steel FeZn 8 P1	093006324
Item	Qty	Description	Material	Part Number
		Scale: 3 : 1	Drawn: CABLHE	Checked: PGU
		Appr.: JOOL	ECO: 11760	Date: 2017-07-07
 <b>Assembly Drawing</b>			Drawing No. <b>103005204</b>	Issue: B Sheet: 1 / (1)

